

DRM270220LT**Weidmüller Interface GmbH & Co. KG**

Klingenbergstraße 26

D-32758 Detmold

Germany

www.weidmueller.com

Product image

Similar to illustration

Individual relays within the D-SERIES DRM

- 2 CO contacts
- AC coils
- With integrated status LED and test button

General ordering data

Version	D-SERIES DRM, Relay, Number of contacts: 2, CO contact, AgNi flash gold-plated, Rated control voltage: 220 V DC, Continuous current: 10 A, Plug-in connection
Order No.	7760056072
Type	DRM270220LT
GTIN (EAN)	4032248855834
Qty.	20 pc(s).

Creation date January 8, 2022 8:01:31 AM CET

Catalogue status 17.12.2021 / We reserve the right to make technical changes.

DRM270220LT**Weidmüller Interface GmbH & Co. KG**

Klingenbergstraße 26

D-32758 Detmold

Germany

www.weidmueller.com

Technical data**Dimensions and weights**

Depth	35.7 mm	Depth (inches)	1.406 inch
Height	27.4 mm	Height (inches)	1.079 inch
Width	21 mm	Width (inches)	0.827 inch
Net weight	30.9 g		

Temperatures

Storage temperature	-40 °C...70 °C	Operating temperature	-40 °C...60 °C
Humidity	35...85 % rel. humidity, no condensation		

Environmental Product Compliance

REACH SVHC	Lead 7439-92-1
------------	----------------

Rated data UL

Certificate No. (cURus)	E312083
-------------------------	---------

Control side

Rated control voltage	220 V DC	Rated current DC	5.2 mA
Power rating	1.2 W	Pull-in/drop-out voltage, typ.	165 V / 22 V DC
Coil resistance	44000 Ω ± 10 %	Status indicator	Green LED

Load side

Rated switching voltage	250 V AC	Continuous current	10 A
Max. switching frequency at rated load	0.1 Hz	Min. switching power	10 mA @ 12 V, 100 mA @ 5 V
Inrush current	20 A / 50 ms	AC switching capacity (resistive), max.	2500 VA
DC switching capacity (resistive), max.	240 W @ 24 V	Switch-on delay	≤ 20 ms
Switch-off delay	≤ 20 ms	Contact type	2 CO contact (AgNi flash gold-plated)
Mechanical service life	20 x 10 ⁶ switching cycles		

General data

Test button available	Yes	
Mechanical switch position indicator	Yes	
Colour	Transparent	
UL94 flammability rating component	Component	Relay cover
	UL94 flammability rating	V-2
	Component	Relay baseplate
	UL94 flammability rating	V-0
	Component	Relay status indicator
	UL94 flammability rating	HB
	Component	Relay test button
	UL94 flammability rating	HB

DRM270220LT

Weidmüller Interface GmbH & Co. KG

Klingenbergstraße 26

D-32758 Detmold

Germany

www.weidmueller.com

Technical data

Insulation coordination

Rated voltage	250 V	Pollution severity	2
Surge voltage category	III	Clearance and creepage distances for control side - load side	≥ 5.5 mm
Dielectric strength for control side - load side	1.8 kV _{eff} / 1 min.	Dielectric strength of neighbouring contacts	1 kV _{eff} / 1 min
Dielectric strength of open contact	1 kV _{eff} / 1 min	Impulse withstand voltage	6 kV (1.2/50 μs)
Protection degree	IP20		

Further details of approvals / standards

Standards	IEC 61810-1, EN 60664-1:2007, EN 61000-6-2:2005, EN 61000-6-4:2007 + A1:2011, UL 508	Certificate No. (cURus)	E312083
-----------	--	-------------------------	---------

Connection data

Wire connection method	Plug-in connection
------------------------	--------------------

Classifications

ETIM 6.0	EC001437	ETIM 7.0	EC001437
ETIM 8.0	EC001437	ECLASS 9.0	27-37-16-01
ECLASS 9.1	27-37-16-01	ECLASS 10.0	27-37-16-01
ECLASS 11.0	27-37-16-01		

Approvals

Approvals



ROHS	Conform
UL File Number Search	E312083

Downloads

Approval/Certificate/Document of Conformity	EU Konformitätserklärung / EU Declaration of Conformity
Engineering Data	CAD data – STEP
Engineering Data	EPLAN, WSCAD
Catalogues	Catalogues in PDF-format
Brochures	

DRM270220LT

Weidmüller Interface GmbH & Co. KG
 Klingenbergstraße 26
 D-32758 Detmold
 Germany

www.weidmueller.com

Drawings

Wiring diagram

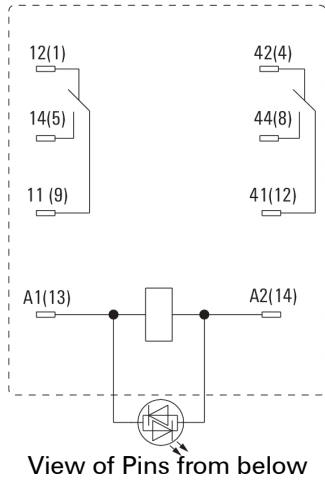

Graph

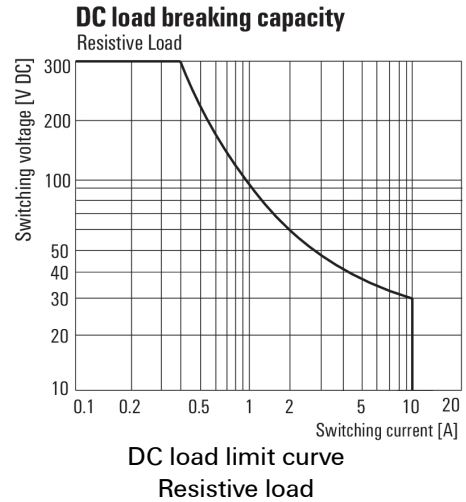

Graph

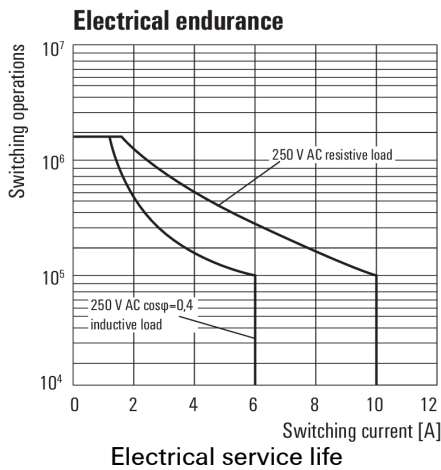

Graph

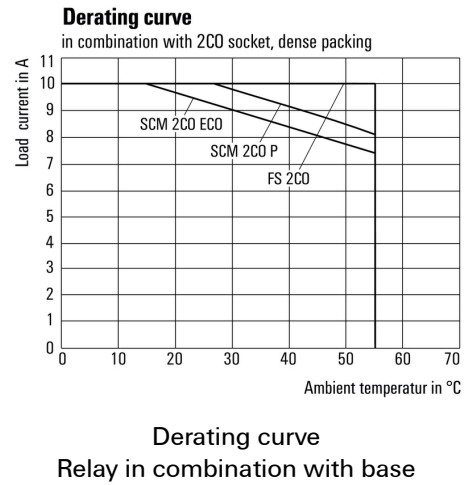

Graph

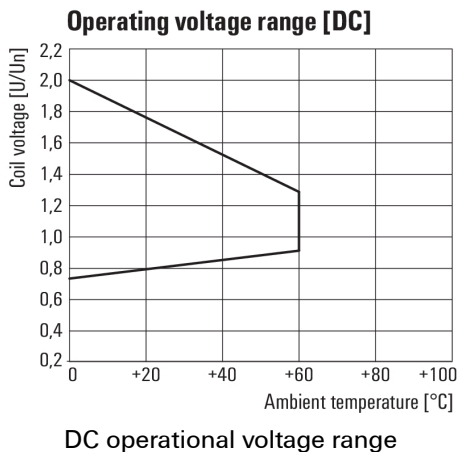

Dimensional drawing

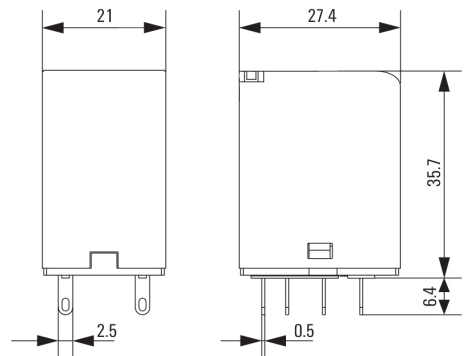

DRM270220LT**Weidmüller Interface GmbH & Co. KG**

Klingenbergstraße 26

D-32758 Detmold

Germany

www.weidmueller.com

Mating connector (fully pluggable)**Sockets**

Relay sockets for the D-SERIES DRM relays

- 2 and 4 CO contacts
- Screw and PUSH IN connection
- Standard and low heights

General ordering data

Type	FS 4CO	Version
Order No.	7760056107	D-SERIES DRM, Relay socket, Number of contacts: 4, CO contact,
GTIN (EAN)	4032248855575	Continuous current: 10 A, Screw connection
Qty.	10 pc(s).	
Type	SCM 2CO P	Version
Order No.	7760056362	D-SERIES DRM, Relay socket, Number of contacts: 2, CO contact,
GTIN (EAN)	6944169772269	Continuous current: 12 A, PUSH IN
Qty.	10 pc(s).	
Type	FS 2CO	Version
Order No.	7760056106	D-SERIES DRM, Relay socket, Number of contacts: 2, CO contact,
GTIN (EAN)	4032248855582	Continuous current: 12 A, Screw connection
Qty.	10 pc(s).	
Type	SCM 4CO P	Version
Order No.	7760056363	D-SERIES DRM, Relay socket, Number of contacts: 4, CO contact,
GTIN (EAN)	6944169772276	Continuous current: 6 A, PUSH IN
Qty.	10 pc(s).	
Type	SCM 2CO ECO	Version
Order No.	7760056263	D-SERIES DRM, Relay socket, Number of contacts: 2, CO contact,
GTIN (EAN)	6944169662966	Continuous current: 12 A, Screw connection
Qty.	10 pc(s).	
Type	SCM 4CO ECO	Version
Order No.	7760056264	D-SERIES DRM, Relay socket, Number of contacts: 4, CO contact,
GTIN (EAN)	6944169662973	Continuous current: 6 A, Screw connection
Qty.	10 pc(s).	

DRM270220LT

Weidmüller Interface GmbH & Co. KG
 Klingenbergstraße 26
 D-32758 Detmold
 Germany

www.weidmueller.com

Accessories

ESG 6/15

**Guaranteed long service life: ESG**

The multi-colour and multi-format labels have a strong adhesive layer to ensure the best possible adhesion to the underlying surface. Double laminated polyester makes the basic material very thin and yet extremely tear-resistant.

Your benefits with MultiMark

- "Different materials for various requirements"
- Can be used with equipment from many manufacturers
- Device markers with a familiar design

General ordering data

Type	ESG 6/15 MM WS	Version
Order No.	2619940000	ESG, Device markers, 6 x 15 mm, white
GTIN (EAN)	4050118626148	
Qty.	3,000 pc(s).	

LED



Pluggable protective modules for the D-SERIES relay sockets, with optional protective functions.

- With green LED

General ordering data

Type	RIM 3 110/230VUC	Version
Order No.	7940018455	D-SERIES, LED module, Rated control voltage: 110...230 V UC, Plug-in connection
GTIN (EAN)	4032248878185	
Qty.	20 pc(s).	

DRM270220LT

Weidmüller Interface GmbH & Co. KG
 Klingenbergstraße 26
 D-32758 Detmold
 Germany

www.weidmueller.com

Accessories

ESG 6/17



Guaranteed long service life: ESG

The multi-colour and multi-format labels have a strong adhesive layer to ensure the best possible adhesion to the underlying surface. Double laminated polyester makes the basic material very thin and yet extremely tear-resistant.

Your benefits with MultiMark

- “Different materials for various requirements”
- Can be used with equipment from many manufacturers
- Device markers with a familiar design

General ordering data

Type	ESG 6/17 MM WS	Version
Order No.	2005100000	ESG, Device markers, 6 x 17 mm, white
GTIN (EAN)	4050118390728	
Qty.	3,000 pc(s).	

Retaining clips



Retaining clip for D-SERIES DRM relays

- Metal and plastic retaining clip

General ordering data

Type	SCM CLIP P	Version
Order No.	7760056367	D-SERIES DRM, Retaining clip
GTIN (EAN)	6944169773334	
Qty.	5 pc(s).	
Type	DRM/DRL CLIP M	Version
Order No.	7760056108	D-SERIES, Retaining clip
GTIN (EAN)	4032248855568	
Qty.	10 pc(s).	

DRM270220LT

Weidmüller Interface GmbH & Co. KG
 Klingenbergstraße 26
 D-32758 Detmold
 Germany

www.weidmueller.com

Accessories

LED / free-wheel diode



Pluggable protective modules for the D-SERIES relay sockets, with optional protective functions.

- With green LED and free-wheeling diode

General ordering data

Type	RIM 2 110/230VDC	Version
Order No.	7760056017	D-SERIES, LED module with freewheel diode, Rated control voltage:
GTIN (EAN)	4032248896615	110...230 V DC, Plug-in connection
Qty.	10 pc(s).	

Custom printing



ESG is the tried-and-tested marker in MultiCard format for use on many well-known electrical devices. The result is high-quality device marking with a high-contrast appearance.

Various types are available for devices from manufacturers like Siemens, ABB, Beckhoff etc. Advantages at a glance:

- Tags for universal usage, self-adhesive or clip-on tags, depending on type
- For aligned equipment, e.g. circuit breakers, we supply ESG markers for clipping onto tag rails
- Individual laser-quality printing according to specifications

For custom printing: Please send us a file of our labeling software M-Print PRO or M-Print PRO Online (without installation) for your labeling specifications.

General ordering data

Type	ESG 9/26 SCM ECO MC SDR	Version
Order No.	1525800000	ESG, Device markers x 26 mm, PA 66, Colour: To customer
GTIN (EAN)	4050118331875	specification
Qty.	80 pc(s).	

DRM270220LT

Weidmüller Interface GmbH & Co. KG
 Klingenbergstraße 26
 D-32758 Detmold
 Germany

www.weidmueller.com

Accessories

Protection modules



Pluggable protective modules for the D-SERIES relay sockets, with optional protective functions.

- With free-wheeling diode or RC filter

General ordering data

Type	RIM 1 6/230VDC	Version	
Order No.	7760056169	D-SERIES, Free-wheeling diode, Rated control voltage: 6...230 V, Plug-	
GTIN (EAN)	4032248967728	in connection	
Qty.	10 pc(s).		

Blank



ESG is the tried-and-tested marker in MultiCard format for use on many well-known electrical devices. The result is high-quality device marking with a high-contrast appearance.

Various types are available for devices from manufacturers like Siemens, ABB, Beckhoff etc. Advantages at a glance:

- Tags for universal usage, self-adhesive or clip-on tags, depending on type
- For aligned equipment, e.g. circuit breakers, we supply ESG markers for clipping onto tag rails
- Individual laser-quality printing according to specifications

For custom printing: Please send us a file of our labeling software M-Print PRO or M-Print PRO Online (without installation) for your labeling specifications.

General ordering data

Type	ESG 6/15 K MC NE WS	Version	
Order No.	1880100000	ESG, Device markers x 15 mm, PA 66, Colour: white, Self-adhesive	
GTIN (EAN)	4032248478781		
Qty.	200 pc(s).		

Type	ESG 6/15 K MC NE GE	Version	
Order No.	1880130000	ESG, Device markers x 15 mm, PA 66, Colour: yellow, Self-adhesive	
GTIN (EAN)	4032248478910		
Qty.	200 pc(s).		

DRM270220LT

Weidmüller Interface GmbH & Co. KG

Klingenbergstraße 26

D-32758 Detmold

Germany

www.weidmueller.com

Accessories

Sockets



Relay sockets for the D-SERIES DRM relays

- 2 and 4 CO contacts
- Screw and PUSH IN connection
- Standard and low heights

General ordering data

Type	FS 4CO	Version
Order No.	7760056107	D-SERIES DRM, Relay socket, Number of contacts: 4, CO contact,
GTIN (EAN)	4032248855575	Continuous current: 10 A, Screw connection
Qty.	10 pc(s).	
Type	SCM 2CO P	Version
Order No.	7760056362	D-SERIES DRM, Relay socket, Number of contacts: 2, CO contact,
GTIN (EAN)	6944169772269	Continuous current: 12 A, PUSH IN
Qty.	10 pc(s).	
Type	FS 2CO	Version
Order No.	7760056106	D-SERIES DRM, Relay socket, Number of contacts: 2, CO contact,
GTIN (EAN)	4032248855582	Continuous current: 12 A, Screw connection
Qty.	10 pc(s).	
Type	SCM 4CO P	Version
Order No.	7760056363	D-SERIES DRM, Relay socket, Number of contacts: 4, CO contact,
GTIN (EAN)	6944169772276	Continuous current: 6 A, PUSH IN
Qty.	10 pc(s).	
Type	SCM 2CO ECO	Version
Order No.	7760056263	D-SERIES DRM, Relay socket, Number of contacts: 2, CO contact,
GTIN (EAN)	6944169662966	Continuous current: 12 A, Screw connection
Qty.	10 pc(s).	
Type	SCM 4CO ECO	Version
Order No.	7760056264	D-SERIES DRM, Relay socket, Number of contacts: 4, CO contact,
GTIN (EAN)	6944169662973	Continuous current: 6 A, Screw connection
Qty.	10 pc(s).	

DRM270220LT

Weidmüller Interface GmbH & Co. KG
 Klingenbergstraße 26
 D-32758 Detmold
 Germany

www.weidmueller.com

Accessories

Blank



ESG is the tried-and-tested marker in MultiCard format for use on many well-known electrical devices. The result is high-quality device marking with a high-contrast appearance.

Various types are available for devices from manufacturers like Siemens, ABB, Beckhoff etc. Advantages at a glance:

- Tags for universal usage, self-adhesive or clip-on tags, depending on type
- For aligned equipment, e.g. circuit breakers, we supply ESG markers for clipping onto tag rails
- Individual laser-quality printing according to specifications

For custom printing: Please send us a file of our labeling software M-Print PRO or M-Print PRO Online (without installation) for your labeling specifications.

General ordering data

Type	ESG 6/17 K MC NE WS	Version
Order No.	1880120000	ESG, Device markers x 17 mm, PA 66, Colour: white, Self-adhesive
GTIN (EAN)	4032248478804	
Qty.	200 pc(s).	
Type	ESG 6/17 K MC NE GE	Version
Order No.	1880110000	ESG, Device markers x 17 mm, PA 66, Colour: yellow, Self-adhesive
GTIN (EAN)	4032248478798	
Qty.	200 pc(s).	

DRM270220LT

Weidmüller Interface GmbH & Co. KG
 Klingenbergstraße 26
 D-32758 Detmold
 Germany

www.weidmueller.com

Accessories

Blank



ESG is the tried-and-tested marker in MultiCard format for use on many well-known electrical devices. The result is high-quality device marking with a high-contrast appearance.

Various types are available for devices from manufacturers like Siemens, ABB, Beckhoff etc. Advantages at a glance:

- Tags for universal usage, self-adhesive or clip-on tags, depending on type
- For aligned equipment, e.g. circuit breakers, we supply ESG markers for clipping onto tag rails
- Individual laser-quality printing according to specifications

For custom printing: Please send us a file of our labeling software M-Print PRO or M-Print PRO Online (without installation) for your labeling specifications.

General ordering data

Type	ESG 9/26 SCM ECO MC NE ...	Version
Order No.	1520980000	ESG, Device markers x 26 mm, PA 66, Colour: white
GTIN (EAN)	4050118327939	
Qty.	80 pc(s).	
Type	ESG 9/26 SCM ECO MC NE ...	Version
Order No.	1520990000	ESG, Device markers x 26 mm, PA 66, Colour: yellow
GTIN (EAN)	4050118327861	
Qty.	80 pc(s).	
Type	ESG 9/26 SCM ECO MC NE ...	Version
Order No.	1521000000	ESG, Device markers x 26 mm, PA 66, Colour: grey
GTIN (EAN)	4050118327878	
Qty.	80 pc(s).	

Data sheet

DRM270220LT

Weidmüller Interface GmbH & Co. KG
 Klingenbergstraße 26
 D-32758 Detmold
 Germany

www.weidmueller.com

Drawings

Miscellaneous

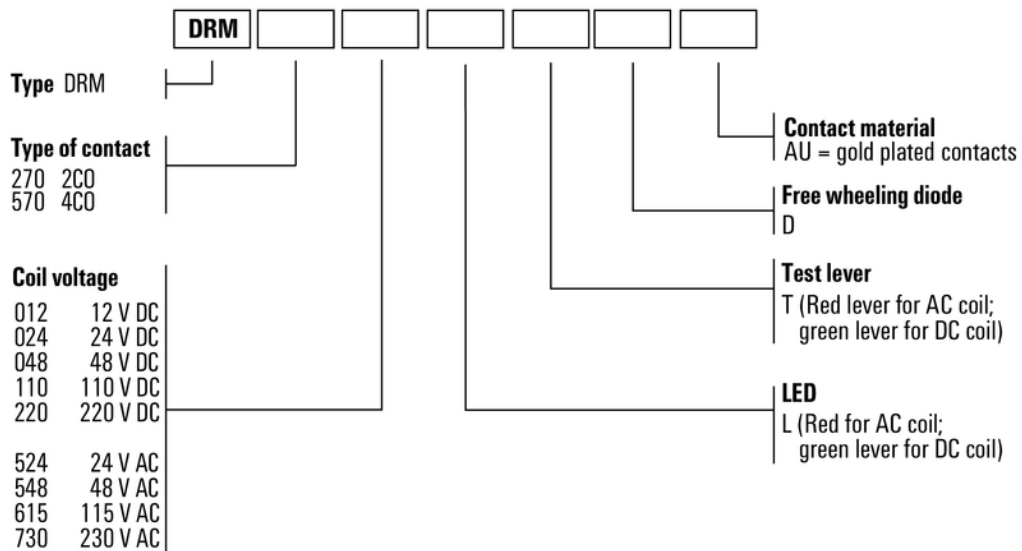

Type codes