

TRS 230VAC RC 1CO AGSNO

Weidmüller Interface GmbH & Co. KG
 Klingenbergstraße 26
 D-32758 Detmold
 Germany

www.weidmueller.com

Product image

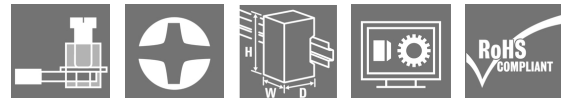

Similar to illustration

- 1 CO contact
- Contact material: AgSnO
- Unique multi-voltage input from 24 to 230 V UC
- Input voltages from 5 V DC to 230 V UC with coloured marking: AC: red, DC: blue, UC: white

General ordering data

Version	TERMSERIES, Relay module, Number of contacts: 1, CO contact AgSnO, Rated control voltage: 230 V AC $\pm 10\%$, Continuous current: 6 A, Screw connection, Test button available: No
Order No.	2152920000
Type	TRS 230VAC RC 1CO AGSNO
GTIN (EAN)	4050118426960
Qty.	10 pc(s).

Creation date January 4, 2022 8:13:56 AM CET

Catalogue status 17.12.2021 / We reserve the right to make technical changes.

TRS 230VAC RC 1CO AGSNO
Weidmüller Interface GmbH & Co. KG

Klingenbergstraße 26

D-32758 Detmold

Germany

www.weidmueller.com

Technical data
Dimensions and weights

Depth	87.8 mm	Depth (inches)	3.457 inch
Height	89.6 mm	Height (inches)	3.528 inch
Width	6.4 mm	Width (inches)	0.252 inch
Net weight	31 g		

Temperatures

Storage temperature	-40 °C...85 °C	Operating temperature	-40 °C...60 °C
Humidity	5-95% relative humidity, T _u = 40°C, without condensation		

Environmental Product Compliance

REACH SVHC	Lead 7439-92-1
------------	----------------

Rated data UL

Ambient temperature (operational), max.	60 °C	Output current derating (ohmic)	5 A @ 60 °C, 6 A @ 55 °C
Connection cross-section AWG, min.	AWG 26	Connection cross-section AWG, max.	AWG 14
Type of conductor	rigid copper conductor, flexible copper conductor	Tightening torque, max.	0.4 Nm
Pollution severity level	2		

Control side

Rated control voltage	230 V AC ± 10 %	Rated current AC	8.5 mA
Power rating	2 VA	Pull-in/drop-out voltage, typ.	169 V / 85 V AC
Pull-in/drop-out current, typ.	7 mA / 3.3 mA AC	Status indicator	Green LED
Protective circuit	Rectifier, RC element	RC filter	94 Ω / 100 nF
Coil voltage of the replacement relay deviating from the rated control voltage	Yes	Coil voltage of the replacement relay	60 V DC

Load side

Rated switching voltage	250 V AC	Continuous current	6 A
Max. switching frequency at rated load	0.1 Hz	Max. switching voltage, DC	250 V
Min. switching power	100 mA @ 12 V	Inrush current	30 A / 20 ms
AC switching capacity (resistive), max.	1500 VA	DC switching capacity (resistive), max.	144 W @ 24 V
Switch-on delay	≤ 16 ms	Switch-off delay	≤ 41 ms
Contact type	1 CO contact (AgSnO)	Mechanical service life	5 x 10 ⁶ switching cycles

General data

Operating altitude	≤ 2000 m, above sea level	
Rail	TS 35	
Test button available	No	
Mechanical switch position indicator	No	
Colour	black	
UL94 flammability rating component	Component	Housing
	UL94 flammability rating	V-0
	Component	Retaining clip
	UL94 flammability rating	V-0

Creation date January 4, 2022 8:13:56 AM CET

Catalogue status 17.12.2021 / We reserve the right to make technical changes.

2

TRS 230VAC RC 1CO AGSNO

Weidmüller Interface GmbH & Co. KG

Klingenbergstraße 26

D-32758 Detmold

Germany

www.weidmueller.com

Technical data

Insulation coordination

Rated voltage	300 V	Pollution severity	2
Surge voltage category	III	Clearance and creepage distances for control side - load side	≥ 6 mm
Dielectric strength for control side - load side	4 kV _{eff} / 1 Min.	Dielectric strength of open contact	1 kV _{eff} / 1 min
Dielectric strength to mounting rail	4 kV _{eff} / 1 Min.	Impulse withstand voltage	6 kV (1.2/50 μs)
Protection degree	IP20		

Further details of approvals / standards

Standards	EN 50178, EN 55011, EN 61000-6-1, 2, 4	Certificate No. (DNVGL)	TAA00001E5
Certificate no. (cULus)	E141197		

Connection data

Wire connection method	Screw connection	Stripping length, rated connection	8 mm
Tightening torque, max.	0.4 Nm	Clamping range, rated connection	1.5 mm ²
Clamping range, min.	0.14 mm ²	Clamping range, max.	2.5 mm ²
Wire connection cross section AWG, min.	AWG 26	Wire connection cross section AWG, max.	AWG 14
Wire cross-section, solid, min.	0.14 mm ²	Wire cross-section, solid, max.	2.5 mm ²
Wire cross-section, solid, min. (AWG)	AWG 26	Wire cross-section, solid, max. (AWG)	AWG 14
Wire connection cross section, finely stranded, min.	0.14 mm ²	Wire connection cross section, finely stranded, max.	2.5 mm ²
Wire cross-section, finely stranded, min. (AWG)	AWG 26	Wire cross-section, finely stranded, max. (AWG)	AWG 14
Wire connection cross-section, finely stranded with wire-end ferrules DIN 46228/4, min.	0.25 mm ²	Wire connection cross-section, finely stranded with wire-end ferrules DIN 46228/4, max.	2.5 mm ²
Conductor cross-section, flexible, AEH (DIN 46228-1), min.	0.25 mm ²	Conductor cross-section, flexible, AEH (DIN 46228-1), max.	2.5 mm ²
Wire connection cross section, finely stranded, two clampable wires, min.	0.5 mm ²	Wire cross-section, finely stranded, two clampable wires, max.	1 mm ²
Twin wire-end ferrules, min.	0.5 mm ²	Twin wire-end ferrules, max.	1 mm ²
Blade size	size PH0	Gauge to IEC 60947-1	A1, B1

Classifications

ETIM 6.0	EC001437	ETIM 7.0	EC001437
ETIM 8.0	EC001437	ECLASS 9.0	27-37-16-01
ECLASS 9.1	27-37-16-01	ECLASS 10.0	27-37-16-01
ECLASS 11.0	27-37-16-01		

Approvals

Approvals



ROHS	Conform
UL File Number Search	E141197

Creation date January 4, 2022 8:13:56 AM CET

Catalogue status 17.12.2021 / We reserve the right to make technical changes.

3

TRS 230VAC RC 1CO AGSNO**Weidmüller Interface GmbH & Co. KG**

Klingenbergstraße 26

D-32758 Detmold

Germany

www.weidmueller.com**Technical data****Downloads**

Approval/Certificate/Document of Conformity	EU Konformitätserklärung / EU Declaration of Conformity
Engineering Data	CAD data – STEP
Engineering Data	EPLAN, WSCAD, Zuken E3.S
User Documentation	Beipackzettel / Package Insert – multilingual
Catalogues	Catalogues in PDF-format

TRS 230VAC RC 1CO AGSNO

Weidmüller Interface GmbH & Co. KG
 Klingenbergstraße 26
 D-32758 Detmold
 Germany

www.weidmueller.com

Drawings

Wiring diagram

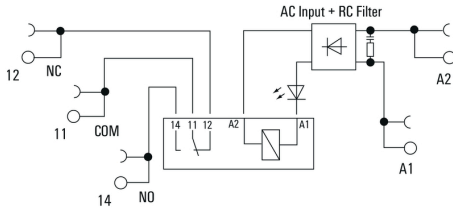

Graph



DC load limit curve

Graph

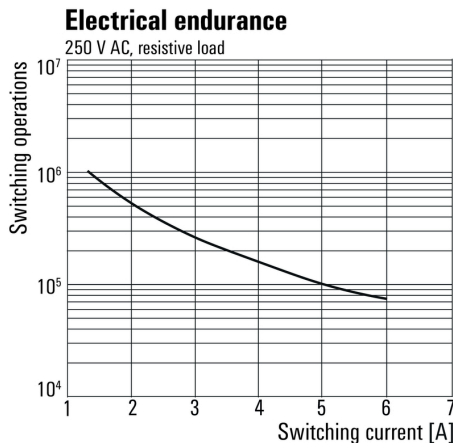

Electrical service life 230 V AC resistive load
 230 V AC resistive load

Dimensional drawing

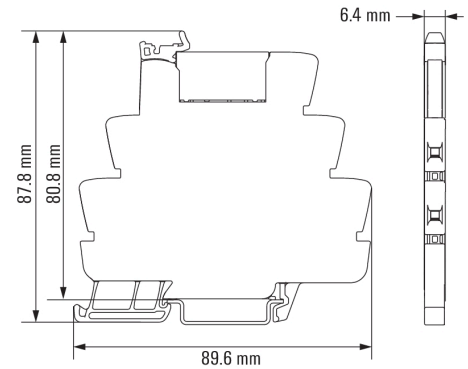

TRS 230VAC RC 1CO AGSNO

Weidmüller Interface GmbH & Co. KG
 Klingenbergstraße 26
 D-32758 Detmold
 Germany

www.weidmueller.com

Accessories

Cross-connections



Adjustable cross-connections

Increase the flexibility of your cross-connections. The TERMSERIES CROSS-CONNECTION (TCC) enables individually adjustable cross-connections with up to 51 poles. The maximum number of pluggable poles has been increased to 32 poles. The strip material can be shortened to the required length very easily. The cross-connectors convince thanks to their easy handling and visibility as well as their universal connection possibilities. An additional web prevents the spring from deforming during assembly.

- Individually adjustable cross-connection with 51 poles
- Additional bar to avoid deformation of the spring
- Increased cross-connection – up to 32 poles possible
- Vibration resistance

General ordering data

Type	TCC 6.4/51 BL	Version
Order No.	2556450000	TERMSERIES, Cross-connector
GTIN (EAN)	4050118566963	
Qty.	10 pc(s).	
Type	TCC 6.4/51 RD	Version
Order No.	2556410000	TERMSERIES, Cross-connector
GTIN (EAN)	4050118566925	
Qty.	10 pc(s).	
Type	TCC 12.8/26 RD	Version
Order No.	2556420000	TERMSERIES, Cross-connector
GTIN (EAN)	4050118566932	
Qty.	10 pc(s).	
Type	TCC 12.8/26 BK	Version
Order No.	2556500000	TERMSERIES, Cross-connector
GTIN (EAN)	4050118567014	
Qty.	10 pc(s).	
Type	TCC 6.4/51 BK	Version
Order No.	2556490000	TERMSERIES, Cross-connector
GTIN (EAN)	4050118567007	
Qty.	10 pc(s).	
Type	TCC 6.4/2 OR	Version
Order No.	2556350000	TERMSERIES, Cross-connector
GTIN (EAN)	4050118566826	
Qty.	10 pc(s).	
Type	TCC 6.4/2 BL	Version
Order No.	2556430000	TERMSERIES, Cross-connector
GTIN (EAN)	4050118566949	
Qty.	10 pc(s).	
Type	TCC 6.4/10 RD	Version
Order No.	2556400000	TERMSERIES, Cross-connector
GTIN (EAN)	4050118566918	
Qty.	10 pc(s).	

TRS 230VAC RC 1CO AGSNO

Weidmüller Interface GmbH & Co. KG
 Klingenbergstraße 26
 D-32758 Detmold
 Germany

www.weidmueller.com

Accessories

Type	TCC 12.8/26 OR	Version
Order No.	2556380000	TERMSERIES, Cross-connector
GTIN (EAN)	4050118566697	
Qty.	10 pc(s).	
Type	TCC 6.4/2 BK	Version
Order No.	2556470000	TERMSERIES, Cross-connector
GTIN (EAN)	4050118566987	
Qty.	10 pc(s).	
Type	TCC 6.4/10 OR	Version
Order No.	2556360000	TERMSERIES, Cross-connector
GTIN (EAN)	4050118566673	
Qty.	10 pc(s).	
Type	TCC 6.4/10 BK	Version
Order No.	2556480000	TERMSERIES, Cross-connector
GTIN (EAN)	4050118566994	
Qty.	10 pc(s).	
Type	TCC 6.4/51 OR	Version
Order No.	2556370000	TERMSERIES, Cross-connector
GTIN (EAN)	4050118566680	
Qty.	10 pc(s).	
Type	TCC 6.4/10 BL	Version
Order No.	2556440000	TERMSERIES, Cross-connector
GTIN (EAN)	4050118566956	
Qty.	10 pc(s).	
Type	TCC 12.8/26 BL	Version
Order No.	2556460000	TERMSERIES, Cross-connector
GTIN (EAN)	4050118566970	
Qty.	10 pc(s).	
Type	TCC 6.4/2 RD	Version
Order No.	2556390000	TERMSERIES, Cross-connector
GTIN (EAN)	4050118566901	
Qty.	10 pc(s).	

TRS 230VAC RC 1CO AGSNO

Weidmüller Interface GmbH & Co. KG
 Klingenbergstraße 26
 D-32758 Detmold
 Germany

www.weidmueller.com

Accessories

Blank



WS markers are the perfect match for the W-series connectors. Thanks to their system compatibility, the WS tags can also be used with the I-series and the Z-series. The large marking surfaces do not only permit long character strings but also multi-line text. WS markers are ideal for labels with long, customised character strings. Thanks to the proven MultiCard format, printing with PrintJet CONNECT oder/or Plotter is possible.

- Can be fitted in strips or individually
- Markers in proven MultiCard format

For custom printing: Please send us a file of our labeling software M-Print PRO or M-Print PRO Online (without installation) for your labeling specifications.

General ordering data

Type	WS 10/6 M MC NE WS	Version
Order No.	181840000	WS, Terminal marker, 10 x 6 mm, Pitch in mm (P): 6.00 Weidmueller,
GTIN (EAN)	4032248310876	Allen-Bradley, white
Qty.	600 pc(s).	

Slotted screwdriver

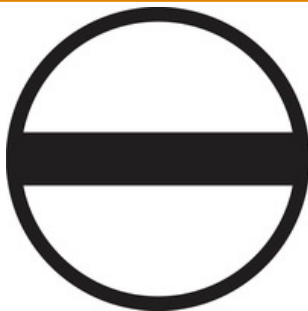

VDE insulated screwdriver sets, for working on live parts up to 1000 V AC and 1500 V DC, DIN EN 60900. IEC 900. Each piece is "GS" safety tested. Blade made from fully hardened, high-alloy chromium-vanadium-molybdenum steel, gun-metal finish.

General ordering data

Type	SDIS SLIM 0.6X3.5X100	Version
Order No.	2749610000	Mounting tool, Blade width (B): 3.5 mm, Blade length: 100 mm, Blade
GTIN (EAN)	4050118896350	thickness (A): 0.6 mm
Qty.	1 pc(s).	

TRS 230VAC RC 1CO AGSNO

Weidmüller Interface GmbH & Co. KG
 Klingenbergstraße 26
 D-32758 Detmold
 Germany

www.weidmueller.com

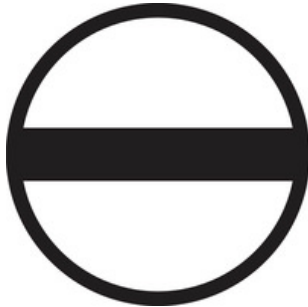
Accessories
Slotted screwdriver

Slotted screwdriver with rounded blade SD DIN 5265, ISO 2380/2, output to DIN 5264, ISO 2380/1. ChromTop tip, SoftFinish grip

General ordering data

Type	SDS 0.6X3.5X100	Version
Order No.	2749340000	Screwdriver, Blade width (B): 3.5 mm, Blade length: 100 mm, Blade thickness (A): 0.6 mm
GTIN (EAN)	4050118895568	
Qty.	1 pc(s).	

WS 12/6

WS/ DEK

MultiMark terminal markers use an innovative composite material made from two components. The hard base contour of the marker snaps securely into the connector. The elastic surface finish makes the marker easy to mount. This specially punched material enables the strips to be stretched to accommodate the slight variations in spacing that tend to add up, especially with long terminal blocks. Another advantage: the excellent printability of the surface material guarantees durable and wear-resistant labelling. A print resolution of 300 dpi also produces a very legible script.

Your benefits with MultiMark

- Firm hold and durable printing
- Continuous strips save installation time
- Easy mounting thanks to an innovative composite material
- Large label field for optimal legibility
- High flexibility thanks to manufacturer independence

General ordering data

Type	WS 12/6 MM WS	Version
Order No.	2007200000	WS, Terminal marker, 12 x 6 mm, Weidmueller, white
GTIN (EAN)	4050118391886	
Qty.	600 pc(s).	

TRS 230VAC RC 1CO AGSNO

Weidmüller Interface GmbH & Co. KG
 Klingenbergstraße 26
 D-32758 Detmold
 Germany

www.weidmueller.com

Accessories

Partition plate



Versatile separation plates

Separation plates can be used to group together signals visually, to electrically isolate modules and to insert markings for a better overview. This makes them a particularly versatile accessory. Separation plates increase the clearance and creepage distances between two modules, thus increasing the rated insulation voltage between two modules to up to 600 V. Double separation plates can be marked with WAD5 or WS10/5 markers and enable continuous cross-connections. Installation is made easier with the perforations to individually break out the cross-connection channels.

- Partition plates visually separates groups from each other
- Indentations for individual breaking out the crossconnection channels
- Partition plates isolates between two modules by increasing the clearance and creepage distances of up to 600 V

General ordering data

Type	TW TXS/TXZ R3.2	Version	
Order No.	1240800000	TERMSERIES, Partition plate	
GTIN (EAN)	4050118028188		
Qty.	10 pc(s).		

Crosshead screwdriver Phillips



Crosshead screwdriver, Phillips, SDK PH DIN 5262, ISO 8764/2-PH, output to ISO 8764-PH, ChromTop tip, SoftFinish grip

General ordering data

Type	SDK PH0 X 60	Version	
Order No.	2749400000	Screwdriver, Blade length: 60 mm	
GTIN (EAN)	4050118895629		
Qty.	1 pc(s).		

TRS 230VAC RC 1CO AGSNO

Weidmüller Interface GmbH & Co. KG
 Klingenbergstraße 26
 D-32758 Detmold
 Germany

www.weidmueller.com

Accessories

Supply module



Space-saving supply modules

Our supply terminals enable potentials to be fed at the input – e.g. neutral or minus potentials – or switched potentials to be fed at the output. In conjunction with precisely fitting cross-connections from the TEMRSERIES, the connections for the cables on the relay module remain free for the cables on the relay module or sensors. No additional feed-through terminal blocks are required, resulting in huge space savings in the panel. At the same time, the wiring is simplified as no double wire-end ferrules are required for the potential feed.

General ordering data

Type	TXZ SUPPLY	Version
Order No.	1240790000	TERMSERIES, Supply module, Number of contacts: 5, , Continuous current: 10 A, Tension-clamp connection
GTIN (EAN)	4050118028164	
Qty.	10 pc(s).	
Type	TXS SUPPLY	Version
Order No.	1240780000	TERMSERIES, Supply module, Number of contacts: 5, , Continuous current: 10 A, Screw connection
GTIN (EAN)	4050118028140	
Qty.	10 pc(s).	
Type	TXP SUPPLY	Version
Order No.	2618940000	TERMSERIES, Supply module, Number of contacts: 5, , Continuous current: 10 A, PUSH IN
GTIN (EAN)	4050118667592	
Qty.	10 pc(s).	

Crosshead screwdriver Phillips



VDE insulated crosshead screwdriver, for Phillips screws, SDIK PH DIN 7438, ISO 8764/2-PH, output to ISO 8764-PH, SoftFinish grip

General ordering data

Type	SDIK PHO X 60	Version
Order No.	2749880000	Screwdriver, Blade length: 60 mm
GTIN (EAN)	4050118897081	
Qty.	1 pc(s).	

TRS 230VAC RC 1CO AGSNO

Weidmüller Interface GmbH & Co. KG
 Klingenbergstraße 26
 D-32758 Detmold
 Germany

www.weidmueller.com

Drawings

Miscellaneous

Type code TERMSERIES electromechanical relay versions

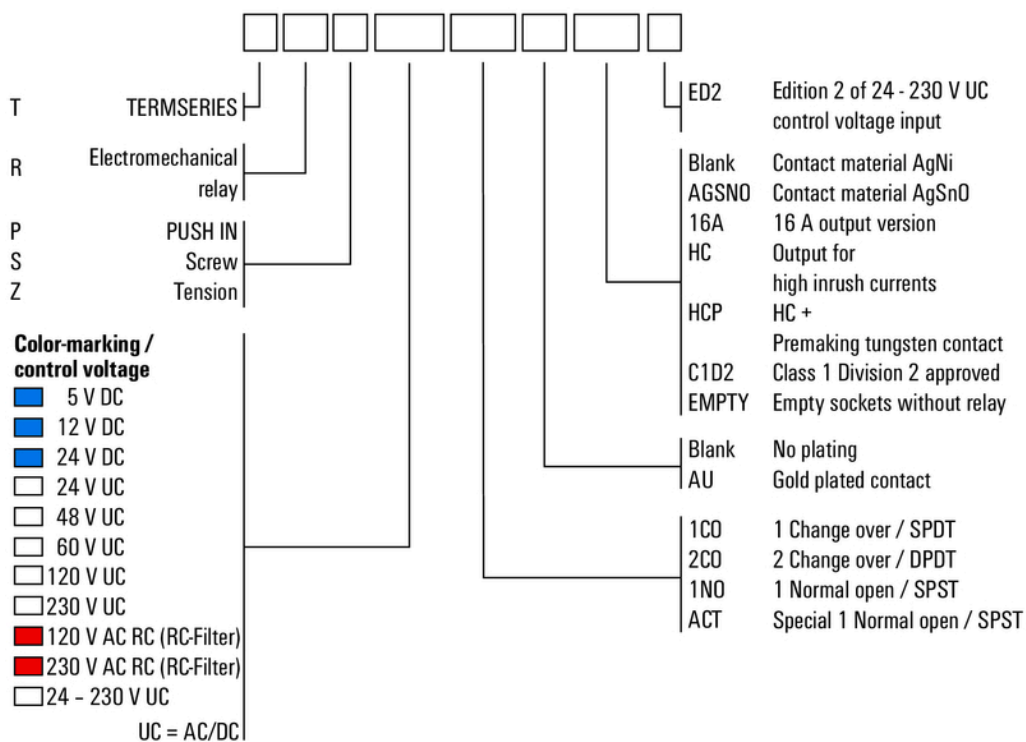

Type codes